



Scheinwerfer

Signalling Lamps

Interior Lamps

Headlamps

Fog Lamps

Nebelleuchten

Auxiliary Lamps

# ZKW - Aftermarket Katalog

Aftermarket Catalogue

gültig ab / valid from 01.01.2012

## BMW 3 Series / E 30

Model	Start of Production	Order Number	OE Number	Beschreibung	Description
E30	1988 - 1992	511.02.000.02 511.02.000.03 <b>MOQ: 120</b>	1 385 945 1 385 946	<b>Nebelscheinwerfer links</b> <b>Nebelscheinwerfer rechts</b> mit Glühlampe H3, 12V/55W, Sockel PK22s, mit siliconisier- tem Kabel, z.B.: OSRAM 64151A	<b>Foglamp left</b> <b>Foglamp right</b> with bulb H3, 12V/55W, socket PK22s, with sili- conised fly lead, e.g. OSRAM 64151A

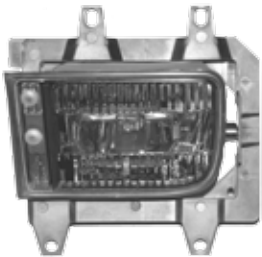

## BMW 3 Series / E 36

E36	1991 - 1994	519.01.000.01 519.02.000.01 <b>MOQ: 27</b>	1 393 271 1 393 272	<b>Hauptscheinwerfer links</b> <b>Hauptscheinwerfer rechts</b> Abblendscheinwerfer mit Linsensystem H1, 12V/55W Fernscheinwerfer mit Parabelsystem H1, 12V/55W Stadtlicht Glassockellampe 12V/W5W, vordere Abdeckscheibe, Labyrinthsystem in Gehäuse und Deckel	<b>Headlamp left</b> <b>Headlamp right</b> Lowbeam with lens system H1, 12V/55W highbeam with para- bolic reflector H1, 12V/55W, contour light with bulb 12V/W5W, front lens,labyrinth system in housing and cover cap
		519.01.600.01 519.02.600.01 <b>MOQ: 45</b>	1 393 849 1 393 850	Ersatzteile: <b>Blenden-Untergruppe links</b> <b>Blenden-Untergruppe rechts</b>	Spare parts: <b>Covering left</b> <b>Covering right</b>
		519.01.000.02 519.02.000.02 <b>MOQ: 27</b>	8 363 079 8 363 080	<b>Hauptscheinwerfer links</b> <b>Hauptscheinwerfer rechts</b> wie 519.01./02. jedoch mit- Noppen am Streuglas	<b>Headlamp left</b> <b>Headlamp right</b> as 519.01./02. but with nops on the scattering lens
	1995 -1999	519.11.000.01 519.12.000.01 <b>MOQ: 27</b>	6312 8 363 495 6312 8 363 496	<b>Hauptscheinwerfer links</b> <b>Hauptscheinwerfer rechts</b> wie 519.01/02. jedoch mit Freiflächenreflektor	<b>Headlamp left</b> <b>Headlamp right</b> as 519.01./02. but with complex surface reflector
		519.11.601.01 519.12.601.01 <b>MOQ: 45</b>	8 363 507 8 363 508	Ersatzteile: <b>Blenden-Untergruppe links</b> <b>Blenden-Untergruppe rechts</b>	Spare parts: <b>Covering left</b> <b>Covering right</b>



## BMW 3 Series / E 36

Model	Start of Production	Order Number	OE Number	Beschreibung	Description
E36	1991 - 99	518.01.000.02 518.01.000.03 <b>MOQ: 220</b>	8 357 389 8 357 390	<b>Nebelscheinwerfer links</b> <b>Nebelscheinwerfer rechts</b> Freiflächenreflektor mit Glühlampe H1 12V/55W Tragrahmen im Stoßfänger verschraubt, Leuchteinheit einclipsbar	<b>Foglamp left</b> <b>Foglamp right</b> Complex surface reflector with bulb H1 12V/55W, supporting frame mounted into bumper snap in fitting of light unit

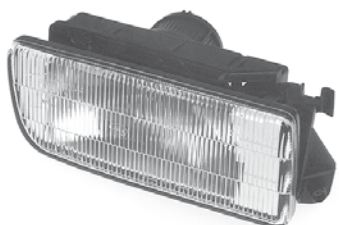





## BMW 3 Series / E46

E46 / 2	1998 - 2006	555,01,000,02 555,01,000,03 <b>MOQ: 290</b>	6317 8371907 6317 8371908	<b>Nebelscheinwerfer links</b> <b>Nebelscheinwerfer rechts</b> Freiflächenreflektor mit Glühlampe HB4, 12V/51W	<b>Foglamp left</b> <b>Foglamp right</b> Complex surface reflector, with bulb HB4, 12V/51W
E46	1998 - 2006	566,01,000,02 566,01,000,03 <b>MOQ: 120</b>	6317 2228613 6317 2228614	<b>Nebelscheinwerfer links</b> <b>Nebelscheinwerfer rechts</b> Freiflächenreflektor mit Glühlampe HB4, 12V/51W	<b>Foglamp left</b> <b>Foglamp right</b> Complex surface reflector, with bulb HB4, 12V/51W
E46 / 2 MÜ	1998 - 2006	566,11,000,02 566,11,000,03 <b>MOQ: 120</b>	6317 7894017 6317 7894018	<b>Nebelscheinwerfer links</b> <b>Nebelscheinwerfer rechts</b> Freiflächenreflektor, wie 566,01,000,02 jedoch Streuglas ohne Verrippung, mit Glühlampe HB4, 12V/51W	<b>Foglamp left</b> <b>Foglamp right</b> Complex surface reflector, as 566,01,000,02 but with clear lens, with bulb HB4, 12V/51W
E46 / 4	1997 - 2005	566,11,000,02 566,11,000,03 <b>MOQ: 120</b>	6317 7894017 6317 7894018	<b>Nebelscheinwerfer links</b> <b>Nebelscheinwerfer rechts</b> Freiflächenreflektor, wie 566,01,000,02 jedoch Streuglas ohne Verrippung, mit Glühlampe HB4, 12V/51W	<b>Foglamp left</b> <b>Foglamp right</b> Complex surface reflector, as 566,01,000,02 but with clear lens, with bulb HB4, 12V/51W

## BMW 3 Series / E46

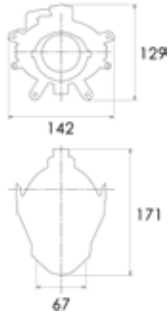
Model	Start of Production	Order Number	OE Number	Beschreibung	Description
E46	1998 - 2001	582,01,000,02 582,01,000,03 <b>MOQ: 40</b>	6 906 493 6 906 494	<b>Hauptscheinwerfer links ECE</b> <b>Hauptscheinwerfer rechts ECE</b> Abblend- und Fernscheinwerfer mit Freiflächenreflektor für Glühlampe H7 12V/55W, Stadtlicht mit Glassockellampe 12V/W5W	<b>Headlamp left</b> <b>Headlamp right</b> Low beam and driving lamp with complex surface reflector for bulb H7 12V/55W, town light with bulb 12V/W5W
		582,03,000,02 582,03,000,03 <b>MOQ: 40</b>	6 906 495 6 906 496	<b>Hauptscheinwerfer links SAE</b> <b>Hauptscheinwerfer rechts SAE</b> wie ECE-Ausführung jedoch ohne Stadtlicht und ohne LWR	<b>Headlamp left</b> <b>Headlamp right</b> as ECE version but without contour light and levelling device
E46/4 MÜ	2001-	583,01,000,02 583,01,000,03 <b>MOQ: 40</b>	6 910 955 6 910 956	<b>Hauptscheinwerfer links ECE RV</b> <b>Hauptscheinwerfer rechts ECE RV</b> Abblend- und Fernscheinwerfer mit Freiflächenreflektor für Glühlampe H7 12V/55W Begrenzungslicht mit Glühlampe H7 12V W5W	<b>Headlamp left ECE right hand traffic</b> <b>Headlamp right ECE right hand traffic</b> Low beam and driving lamp with complex surface reflector for bulb H7 12V/55W Contour light with bulb H7 12V W5W
		2000 - 583,03,000,02 583,03,000,03 <b>MOQ: 40</b>	6 910 963 6 910 964	<b>Hauptscheinwerfer links SAE</b> <b>Hauptscheinwerfer rechts SAE</b> Wie ECE Ausführung jedoch ohne Begrenzungslicht und ohne LWR	<b>Headlamp left SAE</b> <b>Headlamp right SAE</b> Same as ECE version, but without contour light and without levelling device

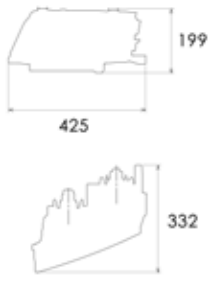
## BMW 3 Series / E46



Model	Start of Production	Order Number	OE Number	Beschreibung	Description
E46/4 MÜ	2001-	608,01,000,01 <b>MOQ: 140</b>	6 911 007	<b>Nebelscheinwerfer</b> Freiflächenreflektor mit Glühlampe H11 12V/55W	<b>Foglamp</b> Complex surface reflec- tor with bulb H11 12V/55W
					
					
E46/4 MÜ	2003 -	584,01,000,02 584,01,000,03 <b>MOQ: 40</b>	7 165 831 7 165 832	<b>Hauptscheinwerfer links ECE</b> <b>Hauptscheinwerfer rechts ECE</b> Wie 583,01,000,02/03 jedoch Abblendscheinwerfer in Luminos twin-lite Ausführung. D2S/35W Abblendlicht H7 12V/55W Zusatzfernlicht W5W Begrenzungslicht	<b>Headlamp left ECE</b> <b>Headlamp right ECE</b> As 583,01,000,02/03 but Lowbeam with luminos twin-light technology D2S/35W Lowbeam H7 12V/35W Add. Highbeam W5W Contour light
					
					
		584,03,000,02 584,03,000,03 <b>MOQ: 40</b>	7 165 833 7 165 834	<b>Hauptscheinwerfer links SAE</b> <b>Hauptscheinwerfer rechts SAE</b> wie ECE-Ausführung jedoch ohne Begrenzungslicht	<b>Headlamp left SAE</b> <b>Headlamp right SAE</b> As ECE version but wit- hout contour light
E46/2 MÜ	1998 - 2006	616,11,000,02 616,11,000,03 <b>MOQ: 290</b>	6317 6920703 6317 6920704	<b>Nebelscheinwerfer links</b> <b>Nebelscheinwerfer rechts</b> Freiflächenreflektor mit Glühlampe HB4, 12V/51W	<b>Foglamp left</b> <b>Foglamp right</b> Complex surface reflector, with bulb HB4, 12V/51W
					

# BMW 3 Series / E90 - E91



Model	Start of Production	Order Number	OE Number	Beschreibung	Description
E90/E91	2005 -	616,01,000,02 616,01,000,03 <b>MOQ: 290</b>	6317 6910791 6317 6910792	<b>Nebelscheinwerfer links</b> <b>Nebelscheinwerfer rechts</b> Freiflächenreflektor mit Glühlampe HB4, 12V/51W	<b>Foglamp left</b> <b>Foglamp right</b> Complex surface reflector, with bulb HB4, 12V/51W
E90/E91	2005 - 2008	631,01,000,02 631,01,000,03 <b>MOQ: 140</b>	6317 6948373 6317 6948374	<b>Nebelscheinwerfer links</b> <b>Nebelscheinwerfer rechts</b> Halogen, Freiflächenreflektor mit Glühlampe H11, 12V/55W LL	<b>Foglamp left</b> <b>Foglamp right</b> Halogen, Complex surface reflector, with bulb H11, 12V/55W LL
		626,03,000,02 626,04,000,02 <b>MOQ: 8</b>	6311 6942747 6311 6942748	<b>Hauptscheinwerfer links ECE RV Halogen</b> <b>Hauptscheinwerfer rechts ECE RV Halogen</b> Abblend- und Fernlicht mit H7, 12V/55W LL Positionslicht mit W5W/12V LL Fahrtrichtungsanzeiger mit PY 21W/12V gelb	<b>Headlamp left ECE right hand traffic halogen</b> <b>headlamp right ECE right hand traffic halogen</b> Low and high beam with H7, 12V/55W LL, Position lamp with W5W/12V LL Turn signal lamp with PY 21W/12V yellow
		626,11,200,02 <b>MOQ: 8</b>	6311 7161444	<b>Reflektor Stand-Lichtringe</b> mit Glühlampe HML 12V 10W LL	<b>Position lighting complete</b> with bulb HML 12V 10W LL
		626,13,000,02 626,14,000,02 <b>MOQ: 8</b>	6311 6942737 6311 6942738	<b>Hauptscheinwerfer links ECE RV Twin lite</b> <b>Hauptscheinwerfer rechts ECE RV Twin Lite</b> Zusatz-Fernlicht mit H7, 12V/55W LL Bi-Xenonmodul für Fern- und Abblendlicht mit MP D1S 35W Positionslicht(Lichtringe) mit HML 12V/10W LL, Fahrtrichtungsanzeiger mit PY 21W/12V gelb	<b>Headlamp left ECE right hand traffic twin lite</b> <b>Headlamp right ECE right hand traffic twin lite</b> Additional high beam with H7, 12V/55W LL Bi-Xenon module for low- and highbeam with MP D1S 35W, position light (light-rings) with HML 12V/10W LL, turn signal lamp with PY 21W/12V yellow
		626,13,100,02 626,14,100,02 <b>MOQ: 8</b>	6311 7161667 6311 7161668	<b>Service Kit links</b> <b>Service Kit rechts</b> Hauptscheinwerfer wie oben, jedoch ohne Xenonbrenner und Vorschaltgerät	<b>Service Kit left</b> <b>Service Kit right</b> Headlamp as above, but without Xenon bulb and ballast

Model	Start of Production	Order Number	OE Number	Beschreibung	Description
		626,23,000,02	6311 6942739	<b>Hauptscheinwerfer links ECE LV Twin lite</b>	<b>Headlamp left ECE left hand traffic twin lite</b>
		626,24,000,02 <b>MOQ: 8</b>	6311 6942740	<b>Hauptscheinwerfer rechts ECE LV Twin Lite</b> Zusatz-Fernlicht mit H7, 12V/55W LL Bi-Xenonmodul für Fern- und Abblendlicht mit MP D1S 35W Positionslicht(Lichtringe) mit HML 12V/10W LL, Fahrtrichtungsanzeiger mit PY 21W/12V gelb	<b>Headlamp right ECE left hand traffic twin lite</b> Additional high beam with H7, 12V/55W LL Bi-Xenon module for low- and highbeam with MP D1S 35W, position light (lightrings) with HML 12V/10W LL, turn signal lamp with PY 21W/12V yellow
		626,23,100,02 626,24,100,02 <b>MOQ: 8</b>	6311 7161673 6311 7161674	<b>Service Kit links</b> <b>Service Kit rechts</b> Hauptscheinwerfer wie oben, jedoch ohne Xenonbrenner und Vorschaltgerät	<b>Service Kit left</b> <b>Service Kit right</b> Headlamp as above, but without Xenon bulb and ballast
E90/E91	2005 - 2008	626,33,000,02	6311 6942735	<b>Hauptscheinwerfer links SAE Twin lite</b>	<b>Headlamp left SAE twin lite</b>
		626,34,000,02 <b>MOQ: 8</b>	6311 6942736	<b>Hauptscheinwerfer rechts SAE Twin Lite</b> Zusatz-Fernlicht mit H7, 12V/55W, Bi-Xenonmodul für Fern- und Abblendlicht mit MP D1S 35W Positionslicht(Lichtringe) mit HML 12V/10W LL, Fahrtrichtungsanzeiger mit PY 21W/12V LL gelb	<b>Headlamp right SAE twin lite</b> Additional high beam with H7, 12V/55W, Bi-Xenon module for low- and high-beam with MP D1S 35W, position light (lightrings) with HML 12V/10W LL, turn signal lamp with PY 21W/12V LL yellow
		626,33,100,02 626,34,100,02 <b>MOQ: 8</b>	6311 7161665 6311 7161666	<b>Service Kit links</b> <b>Service Kit rechts</b> Hauptscheinwerfer wie oben, jedoch ohne Xenonbrenner und Vorschaltgerät	<b>Service Kit left</b> <b>Service Kit right</b> Headlamp as above, but without Xenon bulb and ballast
		626,43,000,02	6311 6942743	<b>Hauptscheinwerfer links ECE RV Bend lite</b>	<b>Headlamp left ECE right hand traffic bend lite</b>
		626,44,000,02 <b>MOQ: 8</b>	6311 6942744	<b>Hauptscheinwerfer rechts ECE RV Bend lite</b> Zusatz-Fernlicht mit H7, 12V/55W, Dynamic-Xenonmodul für Fern- und Abblendlicht (Kurvenlichtmodul) mit MP D1S 35W, Positionslicht (Lichtringe) mit HML 12V/10W LL, Fahrtrichtungsanzeiger mit PY 21W/12V LL gelb	<b>Headlamp right ECE right hand traffic bend lite</b> Additional high beam with H7, 12V/55W, Dynamic-Xenon module for low- and highbeam (adaptive front-light system) with MP D1S 35W, position light (lightrings) with HML 12V/10W LL, turn signal lamp with PY 21W/12V LL yellow
		626,43,100,02 626,44,100,02 <b>MOQ: 8</b>	6311 7161671 6311 7161672	<b>Service Kit links</b> <b>Service Kit rechts</b> Hauptscheinwerfer wie oben, jedoch ohne Xenonbrenner und Vorschaltgerät	<b>Service Kit left</b> <b>Service Kit right</b> Headlamp as above, but without Xenon bulb and ballast



## BMW 3 Series / E90 - E91







Model	Start of Production	Order Number	OE Number	Beschreibung	Description
		626,53,000,02	6311 6942745	<b>Hauptscheinwerfer links ECE LV Bend lite</b>	<b>Headlamp left ECE left hand traffic bend lite</b>
		626,54,000,02 <b>MOQ: 8</b>	6311 6942746	<b>Hauptscheinwerfer rechts ECE LV Bend lite</b> Zusatz-Fernlicht mit H7, 12V/55W, Dynamic-Xenonmodul für Fern- und Abblendlicht (Kurvenlichtmodul) mit MP D1S 35W, Positionslicht (Lichtringe) mit HML 12V/10W LL, Fahrtrichtungsanzeiger mit PY 21W/12V LL gelb	<b>Headlamp right ECE left hand traffic bend lite</b> Additional high beam with H7, 12V/55W, Dynamic-Xenon module for low- and highbeam (adaptive front-light system) with MP D1S 35W, position light (light-rings) with HML 12V/10W LL, turn signal lamp with PY 21W/12V LL yellow
		626,53,100,02	6311 7162081	<b>Service Kit links</b>	<b>Service Kit left</b>
		626,54,100,02 <b>MOQ: 8</b>	6311 7162082	<b>Service Kit rechts</b> Hauptscheinwerfer wie oben, jedoch ohne Xenonbrenner und Vorschaltgerät	<b>Service Kit right</b> Headlamp as above, but without Xenon bulb and ballast
		626,63,000,02	6311 6942741	<b>Hauptscheinwerfer links SAE Bend lite</b>	<b>Headlamp left SAE bend lite</b>
		626,64,000,02 <b>MOQ: 8</b>	6311 6942742	<b>Hauptscheinwerfer rechts SAE Bend lite</b> Zusatz-Fernlicht mit H7, 12V/55W, Dynamic-Xenonmodul für Fern- und Abblendlicht (Kurvenlichtmodul) mit MP D1S 35W, Positionslicht (Lichtringe) mit HML 12V/10W LL, Fahrtrichtungsanzeiger mit PY 21W/12V LL gelb	<b>Headlamp right SAE bend lite</b> Additional high beam with H7, 12V/55W, Dynamic-Xenon module for low- and highbeam (adaptive front-light system) with MP D1S 35W, position light (light-rings) with HML 12V/10W LL, turn signal lamp with PY 21W/12V LL yellow
		626,63,100,02	6311 7161669	<b>Service Kit links</b>	<b>Service Kit left</b>
		626,64,100,02 <b>MOQ: 8</b>	6311 7161670	<b>Service Kit rechts</b> Hauptscheinwerfer wie oben, jedoch ohne Xenonbrenner und Vorschaltgerät	<b>Service Kit right</b> Headlamp as above, but without Xenon bulb and ballast

## BMW 3 Series / E90 LCI - E91 LCI

Model	Start of Production	Order Number	OE Number	Beschreibung	Description
E90 LCI/E91 LCI	2008 -	665,01,000,02	6311 7202581	<b>Hauptscheinwerfer links ECE RV Halogen</b>	<b>Headlamp left ECE right hand traffic halogen</b>
		665,02,000,02 <b>MOQ: 8</b>	6311 7202582	<b>Hauptscheinwerfer rechts ECE RV Halogen</b> Abblend- und Fernlicht mit H7, 12V/55W LL (Freiflächenreflektor), Positionslicht (Licht- ringe) mit HML 12V/10W LL Fahrtrichtungsanzeiger mit PY 12V/24W	<b>Headlamp right ECE right hand traffic halogen</b> Low- and high beam with H7, 12V/55W LL (Complex surface reflector), Position light (lightrings) with HML 12V/10W LL, Turn signal lamp with PY 12V/24W
		665,31,000,02	6311 7202583	<b>Hauptscheinwerfer links ECE RV Twin lite</b>	<b>Headlamp left ECE right hand traffic twin lite</b>
		665,32,000,02 <b>MOQ: 8</b>	6311 7202584	<b>Hauptscheinwerfer rechts ECE RV Twin lite</b> Bi-Xenonmodul für Fern- und Abblendlicht mit MP D1S 35W, Tagfahr- und Positionslicht (Lichtringe) mit H8AR 12V/35W , Fahrtrichtungs- anzeiger in LED Technik	<b>Headlamp right ECE right hand traffic twin lite</b> Bi-Xenon module for high- and lowbeam with MP D1S 35W, Daytime running lamp and position light (lightrings) with H8AR 12V/35W, Turn signal lamp in LED technology
		665,31,100,02	6311 7240247	<b>Service Kit links</b>	<b>Service Kit left</b>
		665,32,100,02 <b>MOQ: 8</b>	6311 7240248	<b>Service Kit rechts</b> Hauptscheinwerfer wie oben, jedoch ohne Xenonbrenner und Vorschaltgerät	<b>Service Kit right</b> Headlamp as above, but without Xenon bulb and ballast
		665,41,000,02	6311 7202585	<b>Hauptscheinwerfer links ECE LV Twin lite</b>	<b>Headlamp left ECE left hand traffic twin lite</b>
		665,42,000,02 <b>MOQ: 8</b>	6311 7202586	<b>Hauptscheinwerfer rechts ECE LV Twin lite</b> Bi-Xenonmodul für Fern- und Abblendlicht mit MP D1S 35W, Tagfahr- und Positionslicht (Lichtringe) mit H8AR 12V/35W, Fahrtrichtungs- anzeiger in LED Technik	<b>Headlamp right ECE left hand traffic twin lite</b> Bi-Xenon module for high- and lowbeam with MP D1S 35W, Daytime running lamp and position light (lightrings) with H8AR 12V/35W, Turn signal lamp in LED technology
		665,41,100,02	6311 7240249	<b>Service Kit links</b>	<b>Service Kit left</b>
		665,42,100,02 <b>MOQ: 8</b>	6311 7240250	<b>Service Kit rechts</b> Hauptscheinwerfer wie oben, jedoch ohne Xenonbrenner und Vorschaltgerät	<b>Service Kit right</b> Headlamp as above, but without Xenon bulb and ballast

## BMW 3 Series / E90 LCI - E91 LCI

Model	Start of Production	Order Number	OE Number	Beschreibung	Description
	665,51,000,02	665,52,000,02	6311 7202587 6311 7202588	<b>Hauptscheinwerfer links SAE Twin lite</b> <b>Hauptscheinwerfer rechts SAE Twin lite</b> Bi-Xenonmodul für Fern- und Abblendlicht mit MP D1S 35W, Tagfahr- und Positionslicht (Lichtringe) mit H8AR 12V/35W, Fahrtrichtungsanzeiger in LED Technik	<b>Headlamp left SAE twin lite</b> <b>Headlamp right SAE twin lite</b> Bi-Xenon module for high- and lowbeam with MP D1S 35W, Daytime running lamp and position light (lightrings) with H8AR 12V/35W, Turn signal lamp in LED technology
	665,51,100,02 665,52,100,02	<b>MOQ: 8</b>	6311 7240245 6311 7240246	<b>Service Kit links</b> <b>Service Kit rechts</b> Hauptscheinwerfer wie oben, jedoch ohne Xenonbrenner und Vorschaltgerät	<b>Service Kit left</b> <b>Service Kit right</b> Headlamp as above, but without Xenon bulb and ballast
	665,61,000,02	665,62,000,02	6311 7202589 6311 7202590	<b>Hauptscheinwerfer links ECE RV Bend lite</b> <b>Hauptscheinwerfer rechts ECE RV Bend lite</b> Dynamic-Xenonmodul für Fern- und Abblendlicht (Kurvenlichtmodul) mit MP D1S 35W, Abbiegelicht mit H3 12V/55W, Tagfahr- und Positionslicht (Lichtringe) mit H8AR 12V/35W, Fahrtrichtungsanzeiger in LED Technik	<b>Headlamp left ECE right hand traffic bend lite</b> <b>Headlamp right ECE right hand traffic bend lite</b> Dynamic-Xenon module for high- and lowbeam (adaptive frontlight system) with MP D1S 35W, Cornering light with H3 12V/55W, Daytime running lamp and position light (lightrings) with H8AR 12V/35W, Turn signal lamp in LED technology
	665,61,100,02 665,62,100,02	<b>MOQ: 8</b>	6311 7240263 6311 7240264	<b>Service Kit links</b> <b>Service Kit rechts</b> Hauptscheinwerfer wie oben, jedoch ohne Xenonbrenner und Vorschaltgerät	<b>Service Kit left</b> <b>Service Kit right</b> Headlamp as above, but without Xenon bulb and ballast

Model	Start of Production	Order Number	OE Number	Beschreibung	Description																		
E90 LCI/E91 LCI	2008 -	665,71,000,02	6311 7202591	<b>Hauptscheinwerfer links ECE LV Bend lite</b> <b>Hauptscheinwerfer rechts ECE LV Bend lite</b> Dynamic-Xenonmodul für Fern- und Abblendlicht (Kurvenlichtmodul) mit MP D1S 35W, Abbiegelicht mit H3 12V/55W, Tagfahr- und Positionslicht (Lichtringe) mit H8AR 12V/35W, Fahrtrichtungsanzeiger in LED Technik	<b>Headlamp left ECE left hand traffic bend lite</b> <b>Headlamp right ECE left hand traffic bend lite</b> Dynamic-Xenon module for high- and lowbeam (adaptive frontlight system) with MP D1S 35W, Cornering light with H3 12V/55W, Day-time running lamp and position light (lightrings) with H8AR 12V/35W, Turn signal lamp in LED technology																		
		665,72,000,02 <b>MOQ: 8</b>	6311 7202592					665,71,100,02	6311 7240265	<b>Service Kit links</b> <b>Service Kit rechts</b> Hauptscheinwerfer wie oben, jedoch ohne Xenonbrenner und Vorschaltgerät	<b>Service Kit left</b> <b>Service Kit right</b> Headlamp as above, but without Xenon bulb and ballast	665,72,100,02 <b>MOQ: 8</b>	6311 7240266	665,81,000,02	6311 7202593	<b>Hauptscheinwerfer links SAE Bend lite</b> <b>Hauptscheinwerfer rechts SAE Bend lite</b> Dynamic-Xenonmodul für Fern- und Abblendlicht (Kurvenlichtmodul) mit MP D1S 35W, Abbiegelicht mit H3 12V/55W, Tagfahr- und Positionslicht (Lichtringe) mit H8AR 12V/35W, Fahrtrichtungsanzeiger in LED Technik	<b>Headlamp left SAE bend lite</b> <b>Headlamp right SAE bend lite</b> Dynamic-Xenon module for high- and lowbeam (adaptive frontlight system) with MP D1S 35W, Cornering light with H3 12V/55W, Day-time running lamp and position light (lightrings) with H8AR 12V/35W, Turn signal lamp in LED technology	665,82,000,02 <b>MOQ: 8</b>	6311 7202594			665,81,100,02	6311 7240261
		665,71,100,02	6311 7240265	<b>Service Kit links</b> <b>Service Kit rechts</b> Hauptscheinwerfer wie oben, jedoch ohne Xenonbrenner und Vorschaltgerät	<b>Service Kit left</b> <b>Service Kit right</b> Headlamp as above, but without Xenon bulb and ballast																		
		665,72,100,02 <b>MOQ: 8</b>	6311 7240266					665,81,000,02	6311 7202593	<b>Hauptscheinwerfer links SAE Bend lite</b> <b>Hauptscheinwerfer rechts SAE Bend lite</b> Dynamic-Xenonmodul für Fern- und Abblendlicht (Kurvenlichtmodul) mit MP D1S 35W, Abbiegelicht mit H3 12V/55W, Tagfahr- und Positionslicht (Lichtringe) mit H8AR 12V/35W, Fahrtrichtungsanzeiger in LED Technik	<b>Headlamp left SAE bend lite</b> <b>Headlamp right SAE bend lite</b> Dynamic-Xenon module for high- and lowbeam (adaptive frontlight system) with MP D1S 35W, Cornering light with H3 12V/55W, Day-time running lamp and position light (lightrings) with H8AR 12V/35W, Turn signal lamp in LED technology	665,82,000,02 <b>MOQ: 8</b>	6311 7202594			665,81,100,02	6311 7240261	<b>Service Kit links</b> <b>Service Kit rechts</b> Hauptscheinwerfer wie oben, jedoch ohne Xenonbrenner und Vorschaltgerät	<b>Service Kit left</b> <b>Service Kit right</b> Headlamp as above, but without Xenon bulb and ballast	665,82,100,02 <b>MOQ: 8</b>	6311 7240262		
		665,81,000,02	6311 7202593	<b>Hauptscheinwerfer links SAE Bend lite</b> <b>Hauptscheinwerfer rechts SAE Bend lite</b> Dynamic-Xenonmodul für Fern- und Abblendlicht (Kurvenlichtmodul) mit MP D1S 35W, Abbiegelicht mit H3 12V/55W, Tagfahr- und Positionslicht (Lichtringe) mit H8AR 12V/35W, Fahrtrichtungsanzeiger in LED Technik	<b>Headlamp left SAE bend lite</b> <b>Headlamp right SAE bend lite</b> Dynamic-Xenon module for high- and lowbeam (adaptive frontlight system) with MP D1S 35W, Cornering light with H3 12V/55W, Day-time running lamp and position light (lightrings) with H8AR 12V/35W, Turn signal lamp in LED technology																		
		665,82,000,02 <b>MOQ: 8</b>	6311 7202594					665,81,100,02	6311 7240261	<b>Service Kit links</b> <b>Service Kit rechts</b> Hauptscheinwerfer wie oben, jedoch ohne Xenonbrenner und Vorschaltgerät	<b>Service Kit left</b> <b>Service Kit right</b> Headlamp as above, but without Xenon bulb and ballast	665,82,100,02 <b>MOQ: 8</b>	6311 7240262										
		665,81,100,02	6311 7240261	<b>Service Kit links</b> <b>Service Kit rechts</b> Hauptscheinwerfer wie oben, jedoch ohne Xenonbrenner und Vorschaltgerät	<b>Service Kit left</b> <b>Service Kit right</b> Headlamp as above, but without Xenon bulb and ballast																		
		665,82,100,02 <b>MOQ: 8</b>	6311 7240262																				

## BMW 3 Series / E92 - E93

E92/E93	2006 -	634,01,000,02 634,01,000,03 <b>MOQ: 140</b>	6317 6937465 6317 6937466	<b>Nebelscheinwerfer links</b> <b>Nebelscheinwerfer rechts</b> Halogen, Freiflächenreflektor mit Glühlampe H8, 12V/35W	<b>Foglamp left</b> <b>Foglamp right</b> Halogen, Complex surface reflector with bulb H8, 12V/35W
					

## BMW 5 Series / E 39

Model	Start of Production	Order Number	OE Number	Beschreibung	Description
E39	1998 - 2000	564,01,000,02 564,01,000,03 <b>MOQ: 203</b>	8 377 941 8 377 942	<b>Nebelscheinwerfer links</b> <b>Nebelscheinwerfer rechts</b> Freiflächenreflektor für Glühlampe H7 12V/55W Einbau im Stoßfänger	<b>Foglamp left</b> <b>Foglamp right</b> Complex surface reflector for bulb H7 12V/55W Mounting into bumper
E39 MÜ	2000 - 2003	589,01,000,02 589,01,000,03 <b>MOQ: 136</b>	6 900 221 6 900 222	<b>Nebelscheinwerfer links</b> <b>Nebelscheinwerfer rechts</b> Freiflächenreflektor für Glühlampe H8 12V/35W	<b>Foglamp left</b> <b>Foglamp right</b> Complex surface reflector for bulb H8 12V/35W
E39	1995 - 2003	566,01,000,02 566,01,000,03 <b>MOQ: 120</b>	6 317 2228613 6 317 2228614	<b>Nebelscheinwerfer links</b> <b>Nebelscheinwerfer rechts</b> mit Glühlampe HB4, 12V/51W,	<b>Foglamp left</b> <b>Foglamp right</b> with bulb HB4, 12V/51W, white

## BMW 5 Series / E 60 - E 61

Model	Start of Production	Order Number	OE Number	Beschreibung	Description
E90/E91	2002 - 2007	616.01.000,02 616.01.000,03 <b>MOQ: 290</b>	6317 6910791 6317 6910792	<b>Nebelscheinwerfer links</b> <b>Nebelscheinwerfer rechts</b> Freiflächenreflektor mit Glühlampe HB4, 12V/51W,	<b>Foglamp left</b> <b>Foglamp right</b> Complex surface reflector, with bulb HB4, 12V/51W

## BMW 5 Series / E60

E60 Sport	2002 - 2007	616.21.000,02 616.21.000,03 <b>MOQ: 290</b>	6317 7897187 6317 7897188	<b>Nebelscheinwerfer links</b> <b>Nebelscheinwerfer rechts</b> Freiflächenreflektor mit Glühlampe HB4, 12V/51W	<b>Foglamp left</b> <b>Foglamp right</b> Complex surface reflector, with bulb HB4, 12V/51W
-----------	-------------	---	------------------------------	---	--







## BMW 7 Series / E65

E65 FL	2001 - 2008	616.31.000,02 616.31.000,03 <b>MOQ: 290</b>	6317 6943415 6317 6943416	<b>Nebelscheinwerfer links</b> <b>Nebelscheinwerfer rechts</b> Freiflächenreflektor mit Glühlampe HB4, 12V/51W	<b>Foglamp left</b> <b>Foglamp right</b> Complex surface reflector, with bulb HB4, 12V/51W
--------	-------------	---	------------------------------	---	--

# BMW 7 Series / F01 - F02

Model	Start of Production	Order Number	OE Number	Beschreibung	Description
	2008 -	655,31,000,02	6311 7182137	<b>Hauptscheinwerfer links ECE RV Twin lite</b> <b>Hauptscheinwerfer rechts ECE RV Twin lite</b> Bi-Xenonmodul für Fern- und Abblendlicht mit MP D1S 35W, Tagfahr- und Positionslicht (Lichtringe) mit H8AR 12V/35W, Fahrtrichtungsanzeiger in LED Technik	<b>Headlamp left ECE right hand traffic Twin lite</b> <b>Headlamp right ECE right hand traffic Twin lite</b> Bi-Xenon module for high- and lowbeam with MP D1S 35W, Daytime running lamp and position light (lightrings) with H8AR 12V/35W, Turn signal lamp in LED technology
		655,32,000,02 <b>MOQ: 6</b>	6311 7182138	<b>Service Kit links</b> <b>Service Kit rechts</b> Hauptscheinwerfer wie oben, jedoch ohne Xenonbrenner und Vorschaltgerät	<b>Service Kit left</b> <b>Service Kit right</b> Headlamp as above, but without Xenon bulb and ballast
		655,41,000,02	6311 7182139	<b>Hauptscheinwerfer links ECE LV Twin lite</b> <b>Hauptscheinwerfer rechts ECE LV Twin lite</b> Bi-Xenonmodul für Fern- und Abblendlicht mit MP D1S 35W, Tagfahr- und Positionslicht (Lichtringe) mit H8AR 12V/35W, Fahrtrichtungsanzeiger in LED Technik	<b>Headlamp left ECE left hand traffic Twin lite</b> <b>Headlamp right ECE left hand traffic Twin lite</b> Bi-Xenon module for high- and lowbeam with MP D1S 35W, Daytime running lamp and position light (lightrings) with H8AR 12V/35W, Turn signal lamp in LED technology
		655,42,000,02 <b>MOQ: 6</b>	6311 7182140	<b>Service Kit links</b> <b>Service Kit rechts</b> Hauptscheinwerfer wie oben, jedoch ohne Xenonbrenner und Vorschaltgerät	<b>Service Kit left</b> <b>Service Kit right</b> Headlamp as above, but without Xenon bulb and ballast
		655,51,000,02	6311 7182141	<b>Hauptscheinwerfer links SAE Twin lite</b> <b>Hauptscheinwerfer rechts SAE Twin lite</b> Bi-Xenonmodul für Fern- und Abblendlicht mit MP D1S 35W, Tagfahr- und Positionslicht (Lichtringe) mit H8AR 12V/35W, Fahrtrichtungsanzeiger in LED Technik	<b>Headlamp left SAE Twin lite</b> <b>Headlamp right SAE Twin lite</b> Bi-Xenon module for high- and lowbeam with MP D1S 35W, Daytime running lamp and position light (lightrings) with H8AR 12V/35W, Turn signal lamp in LED technology
		655,52,000,02 <b>MOQ: 6</b>	6311 7182142	<b>Service Kit links</b> <b>Service Kit rechts</b> Hauptscheinwerfer wie oben, jedoch ohne Xenonbrenner und Vorschaltgerät	<b>Service Kit left</b> <b>Service Kit right</b> Headlamp as above, but without Xenon bulb and ballast
		655,51,100,02	6311 7228429	<b>Service Kit links</b> <b>Service Kit rechts</b> Hauptscheinwerfer wie oben, jedoch ohne Xenonbrenner und Vorschaltgerät	<b>Service Kit left</b> <b>Service Kit right</b> Headlamp as above, but without Xenon bulb and ballast
		655,52,100,02 <b>MOQ: 6</b>	6311 7228430		

## BMW 7 Series / F01 - F02

Model	Start of Production	Order Number	OE Number	Beschreibung	Description
		655,61,000,02	6311 7182149	<b>Hauptscheinwerfer links ECE RV Bend lite</b>	<b>Headlamp left ECE right hand traffic Bend lite</b>
		655,62,000,02 <b>MOQ: 6</b>	6311 7182150	<b>Hauptscheinwerfer rechts ECE RV Bend lite</b> Dynamic-Xenonmodul für Fern-und Abblendlicht (Kurvenlichtmodul) mit MP D1S 35W, Abbiegelicht mit H3 12V/55W, Tagfahr- und Positionslicht (Lichtringe) mit H8AR 12V/35W, Fahrtrichtungsanzeiger in LED Technik	<b>Headlamp right ECE right hand traffic Bend lite</b> Dynamic-Xenon module for high- and lowbeam (adaptive frontlight system) with MP D1S 35W, Cornering light with H3 12V/55W, Daytime running lamp and position light (lightrings) with H8AR 12V/35W, Turn signal lamp in LED technology
		655,61,100,02	6311 7228427	<b>Service Kit links</b>	<b>Service Kit left</b>
		655,62,100,02 <b>MOQ: 6</b>	6311 7228428	<b>Service Kit rechts</b> Hauptscheinwerfer wie oben, jedoch ohne Xenonbrenner und Vorschaltgerät	<b>Service Kit right</b> Headlamp as above, but without Xenon bulb and ballast
		655,71,000,02	6311 7182151	<b>Hauptscheinwerfer links ECE LV Bend lite</b>	<b>Headlamp left ECE left hand traffic Bend lite</b>
		655,72,000,02 <b>MOQ: 6</b>	6311 7182152	<b>Hauptscheinwerfer rechts ECE LV Bend lite</b> Dynamic-Xenonmodul für Fern-und Abblendlicht (Kurvenlichtmodul) mit MP D1S 35W, Abbiegelicht mit H3 12V/55W, Tagfahr- und Positionslicht (Lichtringe) mit H8AR 12V/35W, Fahrtrichtungsanzeiger in LED Technik	<b>Headlamp right ECE left hand traffic Bend lite</b> Dynamic-Xenon module for high- and lowbeam (adaptive frontlight system) with MP D1S 35W, Cornering light with H3 12V/55W, Daytime running lamp and position light (lightrings) with H8AR 12V/35W, Turn signal lamp in LED technology
		655,71,100,02	6311 7228425	<b>Service Kit links</b>	<b>Service Kit left</b>
		655,72,100,02 <b>MOQ: 6</b>	6311 7228426	<b>Service Kit rechts</b> Hauptscheinwerfer wie oben, jedoch ohne Xenonbrenner und Vorschaltgerät	<b>Service Kit right</b> Headlamp as above, but without Xenon bulb and ballast
		655,81,000,02	6311 7182153	<b>Hauptscheinwerfer links SAE Bend lite</b>	<b>Headlamp left SAE Bend lite</b>
		655,82,000,02 <b>MOQ: 6</b>	6311 7182154	<b>Hauptscheinwerfer rechts SAE Bend lite</b> Dynamic-Xenonmodul für Fern-und Abblendlicht (Kurvenlichtmodul) mit MP D1S 35W, Abbiegelicht mit H3 12V/55W, Tagfahr- und Positionslicht (Lichtringe) mit H8AR 12V/35W, Fahrtrichtungsanzeiger in LED Technik	<b>Headlamp right SAE left Bend lite</b> Dynamic-Xenon module for high- and lowbeam (adaptive frontlight system) with MP D1S 35W, Cornering light with H3 12V/55W, Daytime running lamp and position light (lightrings) with H8AR 12V/35W, Turn signal lamp in LED technology
		655,81,100,02	6311 7228423	<b>Service Kit links</b>	<b>Service Kit left</b>
		655,82,100,02 <b>MOQ: 6</b>	6311 7228424	<b>Service Kit rechts</b> Hauptscheinwerfer wie oben, jedoch ohne Xenonbrenner und Vorschaltgerät	<b>Service Kit right</b> Headlamp as above, but without Xenon bulb and ballast

# BMW Others

Model	Start of Production	Order Number	OE Number	Beschreibung	Description
E83/X3 	2004 -	623,01,000,02 <b>MOQ: 108</b>	6317 3416773	<b>Nebelscheinwerfer</b> mit Glühlampe H11 12V 55W	<b>Fog lamp</b> with bulb H11 12V 55W
		518,01,200,02 518,01,201,02 <b>MOQ: 220</b>	6317 8357393 6317 8357394	<b>Tragrahmen links komplett</b> <b>Tragrahmen rechts komplett</b>	<b>Support Housing left</b> <b>Support Housing right</b>

# OPEL

Model	Start of Production	Order Number	Opel catalogue Number	Beschreibung	Description																																												
Astra G	1998 - 2005	515,81,000,02	6710010	<b>Nebelscheinwerfer links</b> <b>Nebelscheinwerfer rechts</b> Freiflächenreflektor	<b>Foglamp left</b> <b>Foglamp right</b> Complex surface reflector																																												
		515,81,000,03 <b>MOQ: 48</b>	6710012			Zafira	1999 - 2005	515,91,000,02	6710011	<b>Nebelscheinwerfer links</b> <b>Nebelscheinwerfer rechts</b> Freiflächenreflektor	<b>Foglamp left</b> <b>Foglamp right</b> Complex surface reflector	515,91,000,03 <b>MOQ: 48</b>	6710014	Corsa	2000 -	575,01,000,02	1710372	<b>Nebelscheinwerfer links</b> <b>Nebelscheinwerfer rechts</b> <b>Nebelscheinwerfer links</b> <b>Nebelscheinwerfer rechts</b> Freiflächenreflektor	<b>Foglamp left</b> <b>Foglamp right</b> <b>Foglamp left</b> <b>Foglamp right</b> Complex surface reflector	575,01,000,03	1710373	575,11,000,02	1710374	575,11,000,03 <b>MOQ: 76</b>	1710375	Vectra C	2002 - 2005	590,01,000,02	6710025	<b>Nebelscheinwerfer links</b> <b>Nebelscheinwerfer rechts</b> Freiflächenreflektor <b>Nebelscheinwerfer links</b> <b>Nebelscheinwerfer rechts</b> ohne Linse	<b>Foglamp left</b> <b>Foglamp right</b> Complex surface reflector <b>Foglamp left</b> <b>Foglamp right</b> without lens	590,01,000,03	6710026	590,01,000,06	6710037	590,01,000,07 <b>MOQ: 76</b>	6710038	Signum	2003 - 2005	590,11,000,06	6710033	<b>Nebelscheinwerfer links</b> <b>Nebelscheinwerfer rechts</b>	<b>Foglamp left</b> <b>Foglamp right</b>	590,11,000,07 <b>MOQ: 76</b>	6710034	Vectra C	2005 -	590,21,000,06	1710365
Zafira	1999 - 2005	515,91,000,02	6710011	<b>Nebelscheinwerfer links</b> <b>Nebelscheinwerfer rechts</b> Freiflächenreflektor	<b>Foglamp left</b> <b>Foglamp right</b> Complex surface reflector																																												
		515,91,000,03 <b>MOQ: 48</b>	6710014			Corsa	2000 -	575,01,000,02	1710372	<b>Nebelscheinwerfer links</b> <b>Nebelscheinwerfer rechts</b> <b>Nebelscheinwerfer links</b> <b>Nebelscheinwerfer rechts</b> Freiflächenreflektor	<b>Foglamp left</b> <b>Foglamp right</b> <b>Foglamp left</b> <b>Foglamp right</b> Complex surface reflector	575,01,000,03	1710373			575,11,000,02	1710374			575,11,000,03 <b>MOQ: 76</b>	1710375	Vectra C	2002 - 2005	590,01,000,02	6710025			<b>Nebelscheinwerfer links</b> <b>Nebelscheinwerfer rechts</b> Freiflächenreflektor <b>Nebelscheinwerfer links</b> <b>Nebelscheinwerfer rechts</b> ohne Linse	<b>Foglamp left</b> <b>Foglamp right</b> Complex surface reflector <b>Foglamp left</b> <b>Foglamp right</b> without lens			590,01,000,03	6710026	590,01,000,06	6710037	590,01,000,07 <b>MOQ: 76</b>	6710038	Signum	2003 - 2005	590,11,000,06	6710033	<b>Nebelscheinwerfer links</b> <b>Nebelscheinwerfer rechts</b>	<b>Foglamp left</b> <b>Foglamp right</b>	590,11,000,07 <b>MOQ: 76</b>	6710034	Vectra C	2005 -	590,21,000,06	1710365
Corsa	2000 -	575,01,000,02	1710372	<b>Nebelscheinwerfer links</b> <b>Nebelscheinwerfer rechts</b> <b>Nebelscheinwerfer links</b> <b>Nebelscheinwerfer rechts</b> Freiflächenreflektor	<b>Foglamp left</b> <b>Foglamp right</b> <b>Foglamp left</b> <b>Foglamp right</b> Complex surface reflector																																												
		575,01,000,03	1710373																																														
		575,11,000,02	1710374																																														
		575,11,000,03 <b>MOQ: 76</b>	1710375																																														
Vectra C	2002 - 2005	590,01,000,02	6710025	<b>Nebelscheinwerfer links</b> <b>Nebelscheinwerfer rechts</b> Freiflächenreflektor <b>Nebelscheinwerfer links</b> <b>Nebelscheinwerfer rechts</b> ohne Linse	<b>Foglamp left</b> <b>Foglamp right</b> Complex surface reflector <b>Foglamp left</b> <b>Foglamp right</b> without lens																																												
		590,01,000,03	6710026																																														
		590,01,000,06	6710037																																														
		590,01,000,07 <b>MOQ: 76</b>	6710038																																														
Signum	2003 - 2005	590,11,000,06	6710033	<b>Nebelscheinwerfer links</b> <b>Nebelscheinwerfer rechts</b>	<b>Foglamp left</b> <b>Foglamp right</b>																																												
		590,11,000,07 <b>MOQ: 76</b>	6710034																																														
Vectra C	2005 -	590,21,000,06	1710365	<b>Nebelscheinwerfer links</b> <b>Nebelscheinwerfer rechts</b> Freiflächenreflektor GL H3 12V 55W	<b>Foglamp left</b> <b>Foglamp right</b> Complex surface reflector for bulb H3 12V 55W																																												
		590,21,000,07 <b>MOQ: 76</b>	1710364																																														

Model	Start of Production	Order Number	Opel catalogue Number	Beschreibung	Description	
Meriva 	2003 - 2006	601,01,000,02	6710031	<b>Nebelscheinwerfer links</b>	<b>Foglamp left</b>	
		601,01,000,03	6710032	<b>Nebelscheinwerfer rechts</b>	<b>Foglamp right</b>	
		601,11,000,02	1710360	<b>Nebelscheinwerfer links</b>	<b>Foglamp left</b>	
		601,11,000,03	1710361	<b>Nebelscheinwerfer rechts</b>	<b>Foglamp right</b>	
		<b>MOQ: 48</b>		Freiflächenreflektor GL H3 12V 55W	Complex surface reflector for bulb H3 12V 55W	
Corsa 	2003 -	612,01,000,02	1216177	<b>Hauptscheinwerfer links RV</b>	<b>Headlamp left right hand traffic</b>	
		612,02,000,02	1216176	<b>Hauptscheinwerfer rechts RV</b>	<b>Headlamp right right hand traffic</b>	
					H7/H7 o. Glühlampe	H7/H7 without bulb
		612,11,000,02	1216297	<b>Hauptscheinwerfer links RV</b>	<b>HL left right hand traffic</b>	
		612,12,000,02	1216296	<b>Hauptscheinwerfer rechts RV</b>	<b>HL right righthand traffic</b>	
		<b>MOQ: 8</b>		D2S/H7 o. Glühlampe <b>Xenon</b>	D2S/H7 without bulb, <b>Xenon</b>	
		612,51,000,02	1216175	<b>Hauptscheinwerfer links LV</b>	<b>HL left left hand traffic</b>	
		612,52,000,02	1216174	<b>Hauptscheinwerfer rechts LV</b>	<b>HL right right hand traffic</b>	
		<b>MOQ: 8</b>		H7/H7 o. Glühlampe	H7/H7 without bulb	
		612,61,000,02	1216299	<b>Hauptscheinwerfer links LV</b>	<b>HL left left hand traffic</b>	
		612,62,000,02	1216298	<b>Hauptscheinwerfer rechts LV</b>	<b>HL right right hand traffic</b>	
		<b>MOQ: 8</b>		D2S/H7 o. Glühlampe <b>Xenon</b>	D2S/H7 without bulb, <b>Xenon</b>	
Astra H/Zafira 	2004 -	621,01,000,02	1710366	<b>Nebelscheinwerfer links</b>	<b>Foglamp left</b>	
		621,01,000,03	1710367	<b>Nebelscheinwerfer rechts</b>	<b>Foglamp right</b>	
		<b>MOQ: 48</b>		Freiflächenreflektor GL H3 12V 55W	Complex surface reflector for bulb H3 12V 55W	
Corsa D 	2007 -	671,01,000,02	1710377	<b>Nebelscheinwerfer links</b>	<b>Foglamp left</b>	
		671,01,000,03	1710376	<b>Nebelscheinwerfer rechts</b>	<b>Foglamp right</b>	
		<b>MOQ: 48</b>		Freiflächenreflektor GL H3 12V 55W	Complex surface reflector for bulb H3 12V 55W	
Insignia 	2008 -	679,01,000,02	1710378	<b>Nebelscheinwerfer links</b>	<b>Foglamp left</b>	
		679,01,000,03	1710379	<b>Nebelscheinwerfer rechts</b>	<b>Foglamp right</b>	
		<b>MOQ: 48</b>		Freiflächenreflektor GL H10 12V42W	Complex surface reflector for bulb H10 12V42W	

# OPEL

Model	Start of Production	Order Number	Opel catalogue Number	Beschreibung	Description
Astra 3400	2009 -	680,01,000,02	1226046	<b>Blinkleuchte links</b> <b>Blinkleuchte rechts</b> mit Glühlampe PSY 24W	<b>Turn signal lamp left</b> <b>Turn signal lamp right</b> with bulb PSY 24W
		680,01,000,03 <b>MOQ: 48</b>	1226095		
		680,41,000,02	1226118	<b>Zusatzscheinwerfer links</b> <b>Zusatzscheinwerfer rechts</b> Astra Sport, mit Glühlampe H10 12V 42W	<b>Fog lamp left</b> <b>Fog lamp right</b> Astra Sport, with bulb H10 12V 42W
		680,41,000,03 <b>MOQ: 48</b>	1226119		
Astra J	2009 -	680,11,000,02	1226096	<b>Nebelscheinwerfer links</b> <b>Nebelscheinwerfer rechts</b> weiss, mit Glühlampe H10 12V 42W	<b>Fog lamp left</b> <b>Fog lamp right</b> white, with bulb H10 12V 42W
		680,11,000,03 <b>MOQ: 48</b>	1226106		
		714,01,000,02	1226122	<b>Blinkleuchte links</b> <b>Blinkleuchte rechts</b> mit Glühlampe PSY 24W	<b>Turn signal lamp left</b> <b>Turn signal lamp right</b> with bulb PSY 24W
		714,01,000,03 <b>MOQ: 88</b>	1226123		
Astra GSI	2011 -	714,01,000,02	1226122	<b>Blinkleuchte links</b> <b>Blinkleuchte rechts</b> mit Glühlampe PSY 24W	<b>Turn signal lamp left</b> <b>Turn signal lamp right</b> with bulb PSY 24W
		714,01,000,03 <b>MOQ: 88</b>	1226123		
					

# DAIMLER

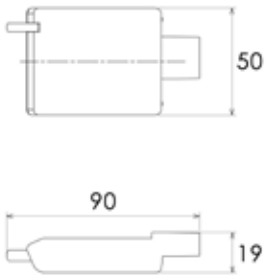
Model	Start of Production	Order Number	OE Number	Beschreibung	Description
E (W124) E (W210) SL	1985 - 1995 1996 - 1991 -	230,28,000,02 <b>MOQ: 750</b>	A 129 8200301	<b>Handschuhkastenleuchte</b> mit Schalter, 63 x 50 mm für 1 Soffitte C5W, Sockel SV8,5 Leuchtscheibe milchig, Einbauöffnung 56 x 44,5 mm	<b>Glove compartment lamp</b> with switch, 63 x 50 mm for tubular lamp C5W, socket SV8,5 Luminous cover plate milky, mounting opening 56 x 44,5 mm
				 	

# MAN

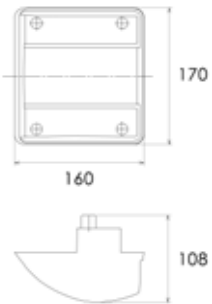
F90 Bus	1986 - 1999 1986 -	470.12.000.01 <b>MOQ: 129</b>	81.25320-6068	<b>Blinkleuchte gelb</b> 199 x 167 mm für 1 Glühlampe 24V/P21W, Sockel BA15s, für vorderen Einbau im Stoßfänger links und rechts, Leuchtkappe gelb, Grundplatte schwarz	<b>Turn signal lamp yellow</b> 199 x 167 mm for 1 bulb 24V/P21W, socket BA15s, for front mounting into the bumper left and right, luminous cover cap yellow, base plate black
				 	
				Ersatzteile: <b>Leuchtkappe gelb</b>	
				Spare parts: <b>Luminous cover cap yellow</b>	

## SKODA

Model	Start of Production	Order Number	OE Number	Beschreibung	Description
Fabia	2000 -	579,01,000,02 579,01,000,03 <b>MOQ: 186</b>	6YO 941 699 6YO 941 700	<b>Nebelscheinwerfer links</b> <b>Nebelscheinwerfer rechts</b> Freiflächenreflektor mit Glühlampe H3 12V/55W	<b>Foglamp left</b> <b>Foglamp right</b> Complex surface reflector with bulb H3 12V/55W

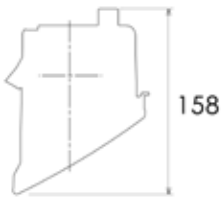
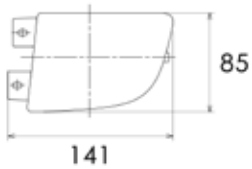

## VOLKSWAGEN

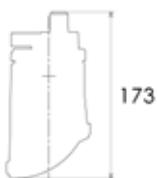
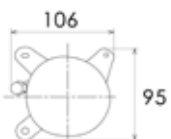

Passat	2000 -	597,01,000,02 597,01,000,03 <b>MOQ: 186</b>	3B7 941 699A 3B7 941 700A	<b>Nebelscheinwerfer links</b> <b>Nebelscheinwerfer rechts</b> Linsensystem mit Glühlampe H3 12V/55W	<b>Foglamp left</b> <b>Foglamp right</b> with lens system with bulb H3 12V/55W
--------	--------	---	------------------------------	---	---



# NEBEL- UND FERNSCHEINWERFER

Model	Start of Production	Order Number	OE Number	Beschreibung	Description
		408.51.000.00 <b>MOQ: 280</b>		<b>Nebelscheinwerfer</b> Ø 150 mm Gehäuse aus schwarzem Kunststoff, Befestigungsschraube M10 für Glühlampe H3, 12V/55W, PK22s	<b>Foglamp</b> Ø 150 mm housing made of black plastic, fixing screw M10, for bulb H3, 12V/55W, PK22s
		408.53.000.00 <b>MOQ: 280</b>		<b>Fernscheinwerfer</b> wie 408.51.000.00	<b>Highbeam</b> as 408.51.000.00

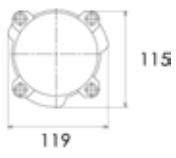
# SYSTEM 100

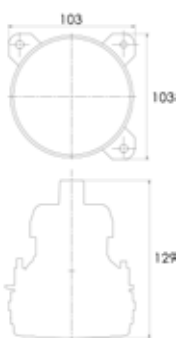
Model	Start of Production	Order Number	OE Number	Beschreibung	Description
		532.01.000.00 <b>MOQ: 120</b>		<b>Ablendscheinwerfer ECE</b> mit Linsensystem Lichtaustritt ø 85 mm Befestigung über Verdrehclips mit Glühlampe H1, 12V/55W	<b>Lowbeam ECE</b> with lens system lightemision ø 85 mm for fitting with turnable clips with bulb H1, 12V/55W
		532.01.000.01 <b>MOQ: 120</b>		<b>Ablendscheinwerfer ECE</b> wie 532.01.000.00 jedoch mit Glühlampe H1, 24V/70W	<b>Lowbeam ECE</b> as 532.01.000.00, but with bulb H1, 24V/70W
		532.12.000.00 <b>MOQ: 120</b>		<b>Ablendscheinwerfer ECE</b> wie 532.01.000.00 jedoch für Linksverkehr	<b>Lowbeam ECE</b> as 532.01.000.00, but for left hand traffic
		532,01,101,02 532,01,101,03 <b>MOQ: 1000</b>		<b>Einstellschraube komplett</b> <b>Einstellschraube ohne</b> <b>Haltebuchse</b>	<b>Adjusting screw</b> <b>Adjusting screw wit-</b> <b>hout bush</b>
		533.01.000.00 <b>MOQ: 290</b>		<b>Fernscheinwerfer ECE</b> Lichtaustritt ø 85 mm Befestigung über Verdrehclips mit Glühlampe H1, 12V/55W	<b>Highbeam ECE</b> lightemision ø 85 mm for fitting with turnable clips with bulb H1, 12V/55W
		533.01.000.01 <b>MOQ: 290</b>		<b>Fernscheinwerfer ECE</b> wie 533.01.000.00 jedoch mit Glühlampe H1, 24V/70W	<b>Highbeam ECE</b> as 533.01.000.00, but with bulb H1, 24V/70W
		533.11.000.00 <b>MOQ: 290</b>		<b>Fernscheinwerfer ECE</b> wie 533.01 jedoch mit Stadtlicht mit Glühlampe H1, 12V/55W	<b>Highbeam ECE</b> as 533.01 but with con- tour light with bulb H1, 12V/55W
			533.11.000.01 <b>MOQ: 290</b>		<b>Fernscheinwerfer ECE</b> wie 533.11 000.00, jedoch mit Glühlampe H1, 24V/70W

# SYSTEM 100

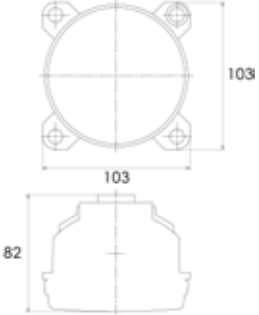
Model	Start of Production	Order Number	OE Number	Beschreibung	Description
  		537.01.000.00 <b>MOQ: 348</b>		<b>Nebelscheinwerfer ECE</b> mit Linsensystem ø 100 x 85 mm Lichtaustritt ø 85 mm Befestigung über Verdrehclips, mit Glühlampe H3, 12V/55W	<b>Foglamp ECE</b> with lens system ø 100 x 85 mm lens ø 85 mm for fitting with turnable clips, with bulb H3, 12V/55W
		537.03.000.00 <b>MOQ: 348</b>		<b>Fernscheinwerfer ECE</b> mit Linsensystem ø 100 x 85 mm Lichtaustritt ø 85 mm Befestigung über Verdrehclips, mit Glühlampe H3 12V/55W	<b>Highbeam ECE</b> with lens System ø 100 x 85 mm lens ø 85 mm for fitting with turnable clips, with bulb H3, 12V/55W

# VOLVO TRUCK

Model	Start of Production	Order Number	OE Number	Beschreibung	Description
-------	---------------------	--------------	-----------	--------------	-------------

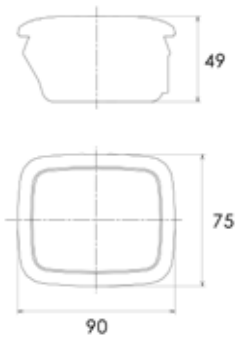

FH FM	2002 -	606.01.000.02 606.02.000.02 <b>MOQ: 245</b>	20456972 20456973	<b>Innenleuchte 24V</b> <b>Innenleuchte 12V</b> mit Glühlampe R10W	<b>Interior lamp 24V</b> <b>Interior lamp 12V</b> with bulb R10W
----------	--------	---	----------------------	--	--

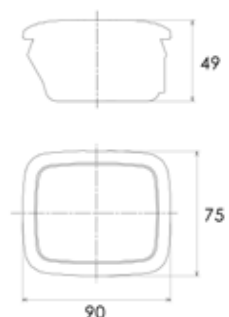

FH FM	2002 -	606.03.000.02 <b>MOQ: 210</b>	20456985	<b>Innenleuchte 24V</b> wie 606.01.000.00 jedoch mit Spot	<b>Interior lamp 24V</b> as 606.01.000.00 but with spot
----------	--------	----------------------------------	----------	---	---

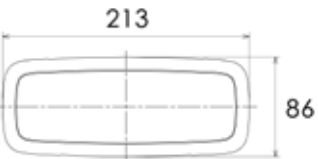

# VOLVO TRUCK

Model	Start of Production	Order Number	OE Number	Beschreibung	Description
FH FM	2002 -	606.04.000.02 <b>MOQ: 245</b>	20517367	<b>Innenleuchte 24V rot</b> wie 606.01.000.00 jedoch mit roter Leuchtkappe und Glühlampe R5W rot mit Schalter	<b>Interior lamp 24V red</b> as 606.01.000.00 but with red luminous cover cap and bulb R5W red with switch
					
					
					
FH FM	2002 -	606.06.000.02 606.08.000.02 <b>MOQ: 252</b>	20456974 20517368	<b>Innenleuchte 24V</b> <b>Innenleuchte 12V</b> mit 2 Glühlampen R10W	<b>Interior lamp 24V</b> <b>Interior lamp 12V</b> with 2 bulbs R10W
					
					
					

Model	Start of Production	Order Number	OE Number	Beschreibung	Description
FH FM	2002 -	606.07.000.02 <b>MOQ: 252</b>	20456978	<b>Innenleuchte 24V</b> wie 606.06.000.00 jedoch ohne Schalter	<b>Interior lamp 24V</b> as 606.06.000.00 but without switch
  					
FH FM	2002 -	606.09.000.02 <b>MOQ: 288</b>	20456976	<b>Innenleuchte 24V</b> wie 606.06.000.00 jedoch mit Spot	<b>Interior lamp 24V</b> as 606.06.000.00 but with spot
  					

# VOLVO TRUCK

Model	Start of Production	Order Number	OE Number	Beschreibung	Description
FH FM	2002 -	606.12.000.02 <b>MOQ: 245</b>	20726636	<b>Innenleuchte 24V rot</b>	<b>Interior lamp 24V red</b>
  					
FH FM	2002 -	606.13.000.02 <b>MOQ: 252</b>	20584060	<b>Innenleuchte 24V gross</b>	<b>Interior lamp 24V</b>
  					

# VOLVO TRUCK

Model	Start of Production	Order Number	OE Number	Beschreibung	Description
FH FM	2002 -	606.14.000.02 <b>MOQ: 245</b>	20862313	<b>Innenleuchte 24V rot titan</b>	<b>Interior lamp 24V red titan</b>

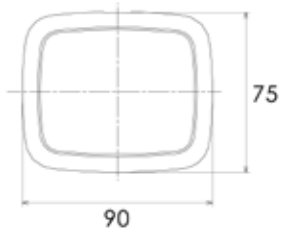

# Aftermarket

## Ansprechpartner / Contact

### **Kloimwieder Siegfried**

Tel: +43 (0) 7416/505-2514

Fax: +43 (0) 7416/505-2599

E-mail: [siegfried.kloimwieder@zkw.at](mailto:siegfried.kloimwieder@zkw.at)

Internet: [www.zkw.at](http://www.zkw.at)

### **Sabine Ebner**

Tel: +43 (0) 7416/505-2530

Fax: +43 (0) 7416/505-2599

E-mail: [sabine.ebner@zkw.at](mailto:sabine.ebner@zkw.at)

Internet: [www.zkw.at](http://www.zkw.at)

